

GOLDWING

We Pride Ourselves
as Being the
World Leader in
GoldWing Accessories!

PERFORMANCE
WINDSHIELD PG.21

BEAR CLAW MIRROR
ACCENT PG.10

CHROME
EYEBROWS™ PG.10

HONDA

FAIRING SCOOP
TRIM PG.10

CHROME GRILL for GL1800



Patent Pending

Choose lit or unlit & you'll smile as onlookers keep children away from what appears as the chromed air intake for a pavement gobbling monster. The amber L.E.D. running lights really look sharp for that screaming red hot performance. No one needs to know it provides visual horsepower only.

Fits: All '01-'08 GL1800 Models

7327	Chrome Grill for GL1800 (ea)	\$59.99
7328	Amber L.E.D. Lighted Grill for GL1800 (ea)	\$119.99

Note: Will not work with Sport/Touring Lamp Kit (P/N 2218).

CHROME DUST
COVER PG.7

*Choose with or without
Running Lights!*

Unfinished
Prototypes
Shown

FAIRING
INTAKE VENT
INSERTS PG.11

FORK BRACE PG.7

SHARK TOOTH
FENDER ACCENTS
PG.6

FRONT FENDER TIP
TRIM PG.6

LIGHTED FORK
TOWER ACCENTS
PG.8

LOWER COWL
CHROME COVERS
PG.12



Rendering Shown-final design may vary.

GOLDWING KÜRYAKYN STYLE!



LUGGAGE RACK
PG.36

ANTENNA FLAG
MOUNT PG.38

REAR AIR FOIL
PG.21 **NEW**

PASSENGER
ARMRESTS PG.22

RIDER
BACKREST
PG.22

TRUNK
TAILLIGHT
ACCENTS PG.33

*Unfinished
Prototype Shown*

SADDLEBAG TOP
ACCENTS PG.15

LIGHTED TRUNK
MOLDING PG.31

NEW INFINITY
LIGHTS PG.32

*Unfinished
Prototype Shown*

*Unfinished
Prototype Shown*

SADDLEBAG
TAILLIGHT
ACCENTS
PG.33

GLOW RING
EXHAUST PG.34

LIGHTED
SADDLEBAG
MOLDING PG.31

NEW LOUVERED
CHROME
BATTERY BOX
COVER PG.14

PASSENGER
FLOORBOARD SIDE
COVERS PG.14

SADDLEBAG BOTTOM
TRIM MOLDING PG.31

REAR WHEEL RING
OF FIRE PG.9

NEW SADDLEBAG SIDE
EMBLEMS PG.15

TRANSFORMER
FLOORBOARDS
PG.29

BOOMERANG
FRAME COVERS
PG.15

More Parts For Your GoldWing in the Following Pages!



NEW PERFORMANCE WINDSHIELD PG.21

NEW BEAR CLAW MIRROR ACCENT PG.10

ACCESSORY SWITCHES PG.18

NEW DASH COVER PG.20

ISO-GRIPS FOR HEATED GRIPS PG.17

NEW DRAGON WINGS PG.20

FAIRING SCOOP TRIM PG.10

CHROME EYEBROWS PG.10

SHARK GILLS PG.13

CHROME GRILL PG.3 **NEW**

SHARK TOOTH FENDER ACCENT PG.6

FAIRING INTAKE VENT INSERTS PG.11

Unfinished Prototype Shown

CHROME DUST COVERS PG.7 **NEW**

FRONT FENDER TIP PG.6

Unfinished Prototype Shown

Unfinished Prototype Shown

CHROME WHEEL SPOKE COVERS PG.9

NEW LIGHTED FORK TOWER ACCENT PG.8

DRIVER FLOORBOARDS PG.23

FAIRING LIGHT II PG.12

ERGO II CRUISE MOUNTS PG.27

L.E.D. FRONT REFLECTOR CONVERSION PG.8

AERO HEAD MARKER LIGHT PG.8

ROTOR COVERS & L.E.D. RING OF FIRE PG.9

NEW WIDE BRAKE PEDAL PAD PG.23

LIGHTNING VALVE COVERS PG.13

LOWER COWL CHROME COVER PG.12

FRONT ACCESSORIES

GOLDWING . GOLDWING . GOLDWING



SHARK TOOTH FENDER ACCENTS for GL1800

Fill in the gaping holes on your front fender with the stylish Shark Tooth Fender Accents. These little beauties add that finishing touch to the empty holes on the front fender.

Fits: '01-'08 GL1800 Models

7320	Shark Tooth Fender Accents (pr)	\$49.99
-------------	--	----------------



FRONT FENDER TIP for GL1800

Combine beauty & protection with our Front Fender Tip! Incorporate our L.E.D. Front Fender Accent (P/N 7303) & create a perfect pair for your front fender! Simple installation.

Fits: '01-'08 GL1800 Models

7321	Front Fender Tip (ea)	\$29.99
-------------	------------------------------	----------------

L.E.D. FRONT FENDER ACCENT for GL1800

Designed to blend with the smooth lines of the GL1800 front fender, this sleek chrome molding encases a slim lens, housing a bright series of L.E.D.'s. Stunning good looks & additional visibility will make this a popular addition to any GL1800.

Fits: '01-'08 GL1800 Models

7303	L.E.D. Front Fender Accent for GL1800 (pr)	\$79.99
-------------	---	----------------



TRICEPTOR FENDER ACCENT for GL1800

WOW! Add the cutting edge in fender tips or move it back & splash the perfect chrome accent on your front fender. You decide where it looks best. With simple peel & stick installation this gem will class up your front fender & cover unsightly stone chips.

Fits: '01-'08 GL1800 Models (As fender tip or front fender ornament)

7340	Triceptor Fender Accent (ea)	\$39.99
-------------	-------------------------------------	----------------

Note: Additional fitment for some Metric Cruisers, page 102.



Rendering
Shown-final
design may vary.



CHROME DUST COVERS for GL1800

Add beauty to the beast! Complement the high tech style of the Kuryakyn Fork Brace with these sleek, stylized Chrome Fork Dust Covers. You'll find the superior proportion & the added splash of chrome in this area striking! A remarkable improvement over the stock plastic fork bridge!

Fits: '01-'08 GL1800 Models (ex. Airbag Models)

8616	Chrome Fork Dust Covers for GL1800 (pr)	\$49.99
-------------	--	----------------

Note: For use with Kuryakyn Fork Brace (P/N 8615).



NEW! Chrome Grill (Page 3)

8616

8615

Unfinished
Prototype
Shown



FRONT FENDER EXTENSION for GL1800

Keep a lot of water & dirt down on the road where it belongs with this functional chrome accessory. Extends fender just over three inches.

Fits: '01-'08 GL1800 Models

7354	Front Fender Extension (ea)	\$29.99
-------------	------------------------------------	----------------

FORK BRACE for GL1800

We couldn't find a fork brace on the market that had the necessary adjustments to cover the variable working tolerances a GoldWing inherently has. Two-piece braces do not allow for any manufacturing variation that affects the width of fork; this can lead to premature wear of the bushings & seals. We went to Crossroads Performance to design everything needed for a top-flight brace. We can now offer you a superbly stylish show-chromed fork brace. We've seen nothing on the market that compares. It will give you the look & the rock solid handling your high-performance GL1800 demands.

Fits: '01-'08 GL1800 (ex. Airbag Models)

8615	Fork Brace for GL1800	\$249.99
8614	Fork Brace with Dust Cover for GL1800	\$299.99

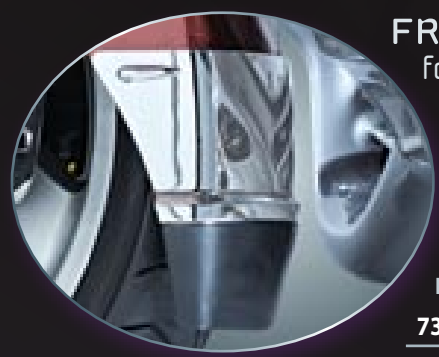

FRONT FENDER EXTENSION for GL1800

This Front Fender Extension for the GL1800 is a must-have item. Besides looking sharp, this will really tame the road spray when riding in the rain. Extending the fender four inches & made of sparkling chrome & black rubber, this neat little piece is easy to install on stock front fenders, or those with the Honda extension previously installed.

Fits: '01-'08 GL1800 Models

7352	Front Fender Extension for GL1800 (ea)	\$69.99
7353	Replacement Rubber for 7352 (ea)	\$16.99



Rendering Shown-final design may vary.

LIGHTED FORK TOWER ACCENTS for GL1800

Add visibility with class. The three spear towers are filled with L.E.D. running lights with the top spear doubling as a turn signal. With plug & play installation & chrome that contours to your front fender, this accent is a must have.

Fits: '01-'08 GL1800 Models (ex. Airbag Models) ('06-'08 GL1800's require P/N 7300 for plug & play installation)

7445 | Lighted Fork Tower Accents for GL1800 (pr) | \$159.99

AERO HEAD MARKER LIGHTS for GL1800

Increase your visibility with these great L.E.D. Marker Lights. With simple plug & play installation on either Honda or Kuryakyn Rotor Covers, they are a must have & complete the bottom of your front forks.

Fits: '01-'08 GL1800 Models ('06-'08 GL1800's require P/N 7300 for plug & play installation)

7458 | Aero Head Marker Lights (pr) | \$69.99

Note: Installs on Kuryakyn or Honda Rotor Covers.



L.E.D. FRONT REFLECTOR CONVERSION for GL1800

This simple conversion replaces the ho-hum amber reflectors on GL1800 lower fork leg covers with a sparkling array of amber L.E.D.'s that function as both running lights & turn signals. Great looks & an added measure of visibility all in one!

Fits: '01-'08 GL1800 Models ('06-'08 GL1800's require P/N 7300 for plug & play installation)

7455 | L.E.D. Front Reflector Conversion (pr) | \$59.99

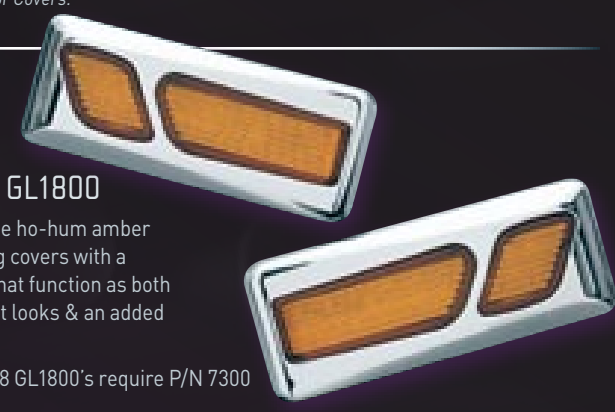

L.E.D. RING OF FIRE™ for GL1800

The Chrome "Ring of Fire" Rotor Covers will really take center stage on your GL1800. The beautifully chromed disc brake rotor covers change the plain, unfinished axle retainer, hub & brake rotor into one sleek gleaming unit. In the daylight, they'll shimmer in the sunshine, but night time brings out another dramatic effect. Brilliant, weather resistant amber L.E.D.'s punctuate the slots in the trim ring, while another inboard set of L.E.D.'s reflect on the front wheel setting it ablaze with your choice of color.

If you prefer a more subtle look, the chrome Rotor Covers are available without the L.E.D. lighting effects. Separate Ring of Fire kits are available as an upgrade if you choose to add them at a later time.

Chrome Rotor Covers with L.E.D. Ring of Fire for GL1800

Fits: '01-'08 GL1800 (ex. Airbag Models)

7451	Chrome Rotor Covers with Amber/Amber Ring of Fire (pr)	\$259.99
7454	Chrome Rotor Covers with Amber/Red & Blue Ring of Fire (pr)	\$299.99



Chrome Rotor Covers

Fits: '01-'08 GL1800 (ex. Airbag Models)

7450	Chrome Rotor Covers (pr)	\$119.99
-------------	---------------------------------	-----------------

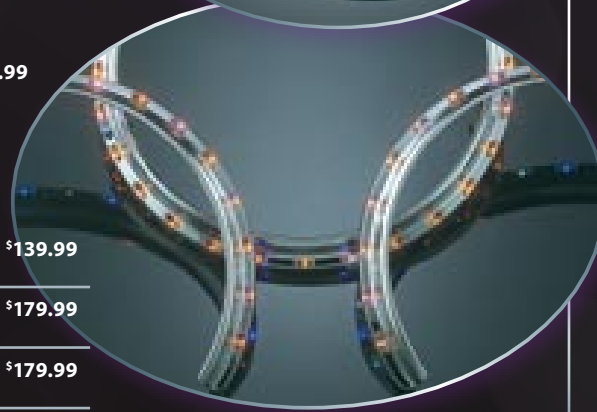

L.E.D. Ring of Fire

Fits: '01-'08 GL1800 Models (Installs on Kuryakyn or Honda Rotor Covers)

7390	L.E.D. Ring of Fire, Amber Light Shining Inward (pr)	\$139.99
7391	L.E.D. Ring of Fire, Blue Light Shining Inward (pr)	\$179.99
7392	L.E.D. Ring of Fire, Blue & Green Light Shining Inward (pr)	\$179.99
7393	L.E.D. Ring of Fire, Red & Blue Light Shining Inward (pr)	\$179.99

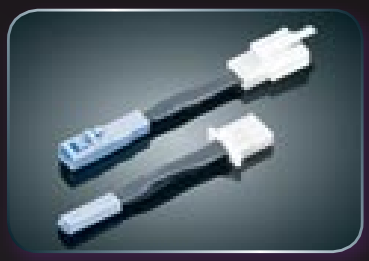

ADAPTER PLUG for Front Turn Signal Accents

Enables you to plug & play Kuryakyn front turn signal accents into your '06-'08 GL1800. Required with Fairing Light II (P/N 7315 & 7316), Aero Head Marker Light (P/N 7458), L.E.D. Front Reflector Conversion (P/N 7455), Lighted Fork Tower Accents (P/N 7445), & Amber Fairing Accent Lights (P/N 4628).

7300	Required for Plug & Play Installation on '06-'08 GL1800 (pr)	\$19.99
-------------	---	----------------

REAR WHEEL RING OF FIRE for GL1800

Patent Pending

We see your love for the Glow from the front wheel Ring of Fire; now light the rest of your GoldWing with the Rear Wheel Ring of Fire. With all the mounting hardware you will need, these beauties cast that same glow out from under your saddlebags. With Red/Red lighting let the light shine.

Fits: '01-'08 GL1800 Models

7395	Rear Wheel Ring of Fire (ea)	\$139.99
-------------	-------------------------------------	-----------------



CHROME WHEEL SPOKE COVERS for GL1800

Patent Pending

No need to spend a ton on chroming your wheel. These easy to install chrome accents make a huge statement. Lots of flash especially if you have our Ring of Fire. Very light weight & even distribution so re-balance is not necessary.

Fits: All '01-'08 GL1800 Front Wheels

7569	Chrome Wheel Spoke Covers for GL1800 (set)	\$139.99
-------------	---	-----------------



7324

HONDA

7323

7322

3900

Unfinished
Prototype
Shown

Unfinished
Prototypes Shown

NEW



Rendering Shown -
final design may vary.

BEAR CLAW MIRROR ACCENT for GL1800

Wrap the top of your mirror with this daring chrome accent. No chintzy chrome trim here, these look great from the driver's position & will WOW others as you pass them by. With a simple peel & stick application, these should be a requirement for all GoldWings.

Fits: '01-'08 GL1800 Models

7324 | Bear Claw Mirror Accent (pr) | **\$59.99**

FAIRING SCOOP TRIM for GL1800 Patent Pending

WOW! Does this easily installed chrome Fairing Scoop Trim add class or what?

Fits: '01-'08 GL1800 Models

7322 | Fairing Scoop Trim (ea) | **\$29.99**



CHROME EYEBROWS™ for GL1800

Patent Pending

Our Chrome Eyebrows close that unsightly gap between your headlamps & fairing. This beautifully radiused chrome strip melds the fairing components together perfectly. With a simple installation, add that classy touch to the front fairing of your GoldWing.

Fits: '01-'08 GL1800 Models

7323 | Chrome Eyebrows for GL1800 (pr) | **\$49.99**

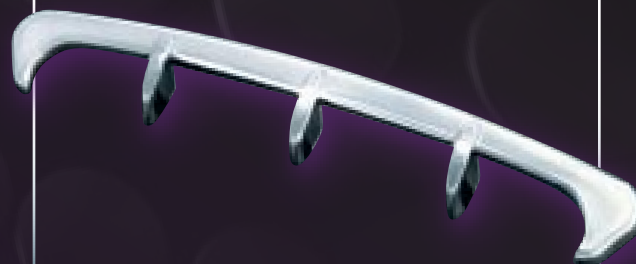

GOLDWING

Choose Between 7-Colors or Amber Running Lights!

L.E.D. FAIRING LIGHTS for GL1800

Give your GoldWing fairing life, as the front fairing scoop & side intake vents are set ablaze with your choice of either amber accent lights or an array of seven colors. These stunning amber accents are running lights up top & double as running lights & accessory turn signals on the sides. For an array of color, choose the mesmerizing seven color L.E.D.'s to glow in one constant hue, flash, or continuously change from one color to the next at any speed. With red, lime, ice blue, sky blue, dark blue, purple, & green the effect is compelling. Both of these kits use plug & play installation with everything you need. Intensify the excitement by combining with our Fairing Scoop Trim (P/N 7322) & Fairing Intake Inserts (P/N 3900).

Fits: '01-'08 GL1800 Models, (L.E.D. Amber Fairing Accent Lights P/N 4628 for '06-'08 GL1800's require P/N 7300 for plug & play installation)

4627	L.E.D. Lizard Fairing Lights for GL1800 (set)	\$189.99
4628	L.E.D. Amber Fairing Accent Lights for GL1800 (set)	\$159.99



PIAA XTREME WHITE PLUS H7 BULB for GL1800

These 4000k bulbs provide 110 watts of performance from only a 55 watt bulb! This means less draw on your battery while still getting the brilliant white light to see those night obstacles & road signs long before a normal halogen bulb.

Fits: '01-'08 GL1800 or other H7 applications

2220	PIAA Xtreme White Plus H7 Bulbs (ea)	\$48.99
------	--------------------------------------	---------

FAIRING INTAKE VENT INSERTS for GL1800

Transform the plain-jane "black hole" fairing air intake vents with stylish chrome inserts. It couldn't be easier - just clean the inlet surface, peel & stick!

Fits: '01-'08 GL1800 Models

3900	Fairing Intake Vent Inserts for GL1800 (pr)	\$32.99
------	---	---------



SPORT/TOURING LAMP KIT for GL1800

1100X Powersports Lamps. This high-quality kit comes complete with two PIAA Powersports 1100X Lamps, two custom mounting brackets, wiring harness, & all necessary hardware & instructions to customize your ride.

Fits: '01-'08 GL1800 Models

2218	Driving Lights for GL1800 (pr)	\$329.99
2221	Replacement Bulb (ea)	\$44.99



SUPER SPOTS Extreme Xenon Super White Bulb

- Extend visual lighted range approximately 30%
- Extreme white appearance, 4100K color rated
- Affordable price for the light you want

2222	Extreme Xenon Super White Bulb H4 Style 60/55 Watt (ea) Fits: All GL1500	\$29.99
2223	Extreme Xenon Super White Bulb H7 Style 55 Watt (ea) Fits: '01-'08 GL1800	\$29.99

H-4 & H-7 Styles!



Note: Will not install with Chrome Grill (P/N's 7327 or 7328).

Limited Lifetime Warranty from WixTech

NEW

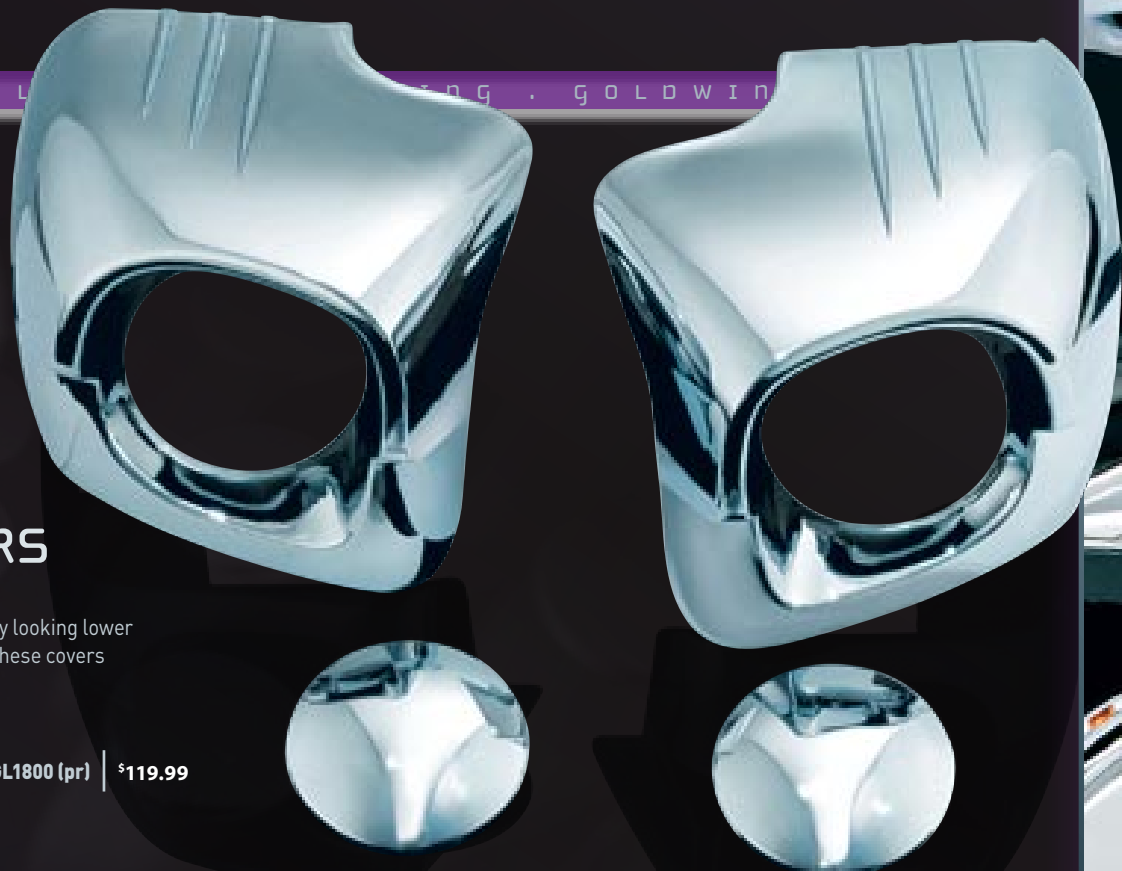

LOWER COWL CHROME COVERS

for GL1800

This streamlined beauty covers that blocky looking lower cowl on your Wing & installs in minutes. These covers work with or without lower fog lights.

Fits: '01-'08 GL1800 Models

3906 | Lower Cowl Chrome Covers for GL1800 (pr) | \$119.99

CHROME TIMING CHAIN COVER SET for GL1800

U.S. Patent # Des. 525,268

If your eyes hurt from looking at the ugly aluminum cam chain cover but you don't want the expense & hassle of having the cover chromed, you're in luck. Our new Chrome Timing Chain Cover Set for GL1800 covers the entire timing chain cover in minutes. Just peel & stick! The strong adhesive is specially designed for high temperatures. A chrome version of the stock screw-in cap is included in the Chrome Timing Chain Cover Set or is available separately.

Fits: '01-'08 GL1800 Models



3909	Chrome Timing Chain Cover Set for GL1800 (set)	\$89.99
3908	Timing Hole Cap for GL1800 (ea)	\$29.99
3907	Replacement Adhesive Pads (set)	\$4.99

FAIRING LIGHT II AND MIRROR LIGHT KIT for GL1800

Our Fairing Light II & Mirror Lights go together like fireworks & the 4th of July! This kit is very easy to install with it's plug-in capability & will save you money & time! Our Fairing Light II features L.E.D. lighted accents which have both running lights as well as accent blinkers. Finish it all off with our L.E.D. Mirror Lights which have a slim design & do not detract or interfere with the viewable mirror surface, plus they add visibility. Buy the complete kit or purchase items separately — either way we have you covered!

Fits: '01-'08 GL1800 Models ('06-'08 GL1800's require P/N 7300 for plug & play installation)

7315	Fairing Light II & Mirror Light Kit (set)	\$119.99
7316	Fairing Light II (pr)	\$79.99
7513	L.E.D. Mirror Lights (pr) <i>Note: Mirror Lights require hard wire installation when installed without additional Kuryakyn front turn signal accent lighting.</i>	\$59.99

>> Don't forget your Adapter Plug needed for Plug & Play Installation. See Page 9.

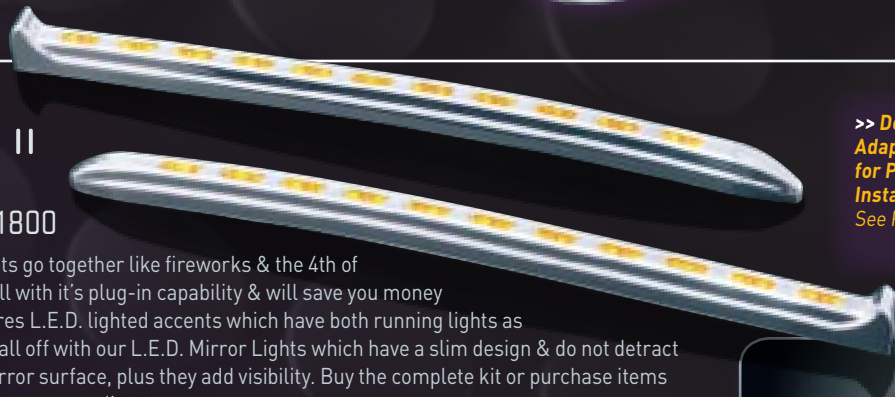
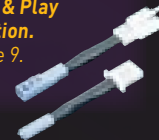



SHARK GILLS for GL1800

U.S. Patent # Des. 521,417

Make your mile munching GoldWing look like the asphalt eating predator it is with our Shark Gill Fairing Accents. Shark Gills are racy, one-piece, chrome-plated accents incorporating a streamlined main beam with six stylish vanes. Instantly gives the fairing exit vent an aggressive, high-speed appearance. They are held in place with a high-tech adhesive & installation requires no drilling or disassembly of the motorcycle; it only takes a few minutes.

Fits: '01-'08 GL1800 Models

7314 | Shark Gill Fairing Accents (pr) | **\$79.99**



LIGHTNING VALVE COVERS

For GL1800 U.S. Patent # Des. 522,930

With this set of Chrome Valve Covers you can create a sleek, uniform look without compromising the integrity of the stock valve covers & risking leakage or less than perfect fitment. Our chrome covers are held on by a two-sided adhesive pad designed specifically for high temperatures. They fit snugly right on top of the stock valve covers, so they look exactly like replacement chrome covers, but without the expense or the potential headaches.

Fits: '01-'08 GL1800 Models

3901	Lightning Valve Cover for GL1800 (set/4)	\$159.99
3902	Replacement Adhesive Pads (set)	\$12.99



3214

Unfinished
Prototype Shown

3911

3913 Unfinished
Prototype Shown

7506



Rendering Shown-
final design may vary.

LOUVERED CHROME BATTERY BOX COVERS

for GL1800 *Patent Pending*

Look at those dull, grey stock battery box covers surrounded by all that glowing rich paint & sparkling chrome. They look a little out of place, don't they? These covers feature a lustrous chrome finish, cutting edge louvered styling, & even provisions for adding custom backlighting. Covers this cool will stand out for their contemporary styling & distinctive good looks.

Fits: '01-'08 GL1800 Models

3913 | Louvered Chrome Battery Box Covers (pr) | \$99.99

PASSENGER FLOORBOARD SIDE COVERS

for GL1800

Directly inboard of the passenger footset is an ugly gray panel that's a total mismatch with the bike's color & stature. This chrome-plated version spruces up the bike nicely & finishes the luxurious look of our Boomerang Frame Covers.

Fits: '01-'08 GL1800 Models

7506 | Passenger Floorboard Side Covers (pr) | \$49.99



TECH-TIPS

When installing any covers with adhesives, make sure the surface is cleaned with rubbing alcohol & dried thoroughly.



FLOORBOARD COVERS for GL1800

Normally, when you flip your stock passenger floorboards into a stowed position, what greets your eyes is dull, dreary & gray. These chrome-plated covers are an easy, inexpensive way to dress up the bottom side of the stock boards. They attach with the stock fasteners for quick installation.

Fits: '01-'08 GL1800 Models

7015 | Floorboard Covers for GL1800 (pr) | \$39.99



BOOMERANG FRAME COVERS with Scuff Protector for GL1800

We've made our enormously popular frame covers even better. We've added carefully designed & perfectly placed rubber scuff protectors in the crucial areas. Very stylish as well.

Fits: '01-'08 GL1800 Models

3911	Boomerang Frame Covers with Scuff Protector (pr)	\$129.99
3912	Replacement Scuff Protection Rubbers (set)	\$11.99

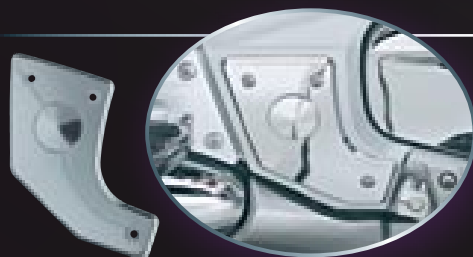

PIVOT COVER for GL1800

This attractive flash of chrome nicely contrasts the matte aluminum finish of the GL1800 perimeter frame. Easy-on, easy-off for service.

Fits: '01-'08 GL1800 Models

7881 | Pivot Cover (pr) | \$29.99

SADDLEBAG SIDE EMBLEMS for GL1800

Patent Pending

Accenting this natural saddlebag body line makes a profound visual statement. Create an illusion of depth, forward motion & elegance. Just peel, stick, & admire!

Fits: '01-'08 GL1800 Models

3214 | Saddlebag Side Emblems (pr) | \$39.99



*Rendering Shown -
final design may vary.*



SADDLEBAG TOP ACCENTS for GL1800

Add some eye candy to your plain-jane saddlebags & some protection to the top corner from those annoying surface scratches. Just stick 'em on & get ready for the compliments.

Fits: '01-'08 GL1800 Models

3207 | Saddlebag Top Accents (pr) | \$39.99



GRIP ACCESSORIES

GOLDENING . FOLLOWING

CHROME ADJUSTABLE LEVER SETS for GL1800

A sleek chrome version of the stock GL1800 levers. Riders retain the reach adjustment of their original levers.

Fits: '01-'08 GL1800 Models

7436 | Chrome Adjustable Lever Sets for GL1800 (pr) | \$42.99



WIDESTYLE LEVER SETS

Our own exclusive design features reamed brass bushings. These are wider & more comfortable chrome levers for '90-'00 GL1500 & '01-'08 GL1800. This reduced reach design is also very popular among riders with small hands.

7430 | Chrome Levers (pr) | \$39.99
Fits: GL1500

7435 | Chrome Levers (pr) | \$39.99
Fits: GL1800



STILETTO™ END-CAPS

Simply replaces the existing end cap on Kuryakyn ISO-Grips or ISO-Flame Grips. Installation is a breeze. Screws supplied for use with or without ISO-Throttle Boss.

6249 | Stiletto End Caps for ISO-Grips (pr) | \$39.99



REPLACEMENT ACCENT RINGS

6220 | Chrome Accent Rings (pr) | \$7.99

6221 | Red Accent Rings (pr) | \$7.99

6222 | Blue Accent Rings (pr) | \$7.99

6223 | Gold Accent Rings (pr) | \$7.99

6224 | Purple Accent Rings (pr) | \$7.99

6225 | Green Accent Rings (pr) | \$7.99

6226 | Black Accent Rings (pr) | \$7.99

OPTIONAL LONGER SCREWS

Allows use of up to 3 accent rings (2 if used with Throttle Boss).

6219 | Longer Stainless Screws (Set/8) | \$6.99



THROTTLE ROCKER™

The Throttle Rocker attaches to the grip with a Velcro strap & allows you to maintain a steady cruising speed without keeping a tight grip on the throttle.

Fits: Any application with a twist grip throttle

6255 | Throttle Rocker, Right (ea) | \$10.99

6256 | Throttle Rocker, Left (ea) | \$10.99

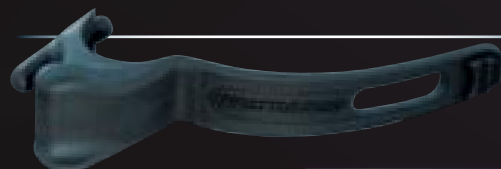

UNIVERSAL THROTTLE BOSS™

Regardless of what type of bike you ride, the Throttle Boss will make riding any distance more comfortable. Designed to fit any type or size grip, the Throttle Boss can be installed in seconds to provide a cushioned "platform" to rest one's palm. When not in use, it can be quickly removed (without tools) & stowed in a jacket pocket, tool bag, etc.

6251 | Universal Throttle Boss (ea) | \$10.99



CRAMPBUSTER CRUISE ASSIST

U.S. Patent # Des. 4875386

The CrampBuster provides a way for comfortable throttle control & dramatically reduces the wrist fatigue often caused by long rides. When downward pressure is applied by your hand, the throttle is regulated effortlessly & accurately without squeezing. No tools are required for installation. Just spring it open, and slip it on.

NARROW

6258 | Fits: Motorcycles with 1" Bars (ea) | \$10.99

6259 | Fits: Motorcycles with 7/8" Bars (ea) | \$10.99

WIDE

6254 | Fits: Motorcycles with 1" Bars (ea) | \$10.99

6257 | Fits: Motorcycles with 7/8" Bars (ea) | \$10.99

Note: Use 6258 & 6254 on grips with 1-7/16" to 1-3/4" outside diameter. Use 6259 & 6257 on grips with 1-1/8" to 1-3/8" outside diameter.

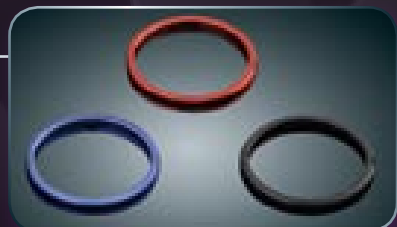

SMOOTH ACCENT RINGS

6264 | Black (pr) | \$8.99

6265 | Red (pr) | \$8.99

6266 | Blue (pr) | \$8.99

GOLDENING

ISO®-THROTTLE BOSS™

Reduce muscle stiffness & fatigue with this small adjustable "paddle". Position under the palm of one's throttle hand & slightly relax the grip on the throttle - but maintain a constant speed!

6250	ISO-Throttle Boss (ea)	\$16.99
6253	ISO-Throttle Boss (pr)	\$29.99
6242	Extended ISO-Throttle Boss (1/4" longer than standard ISO-Throttle Boss) (ea)	\$19.99

Note: ISO-Grips for use with GL1800 Heated Grips (P/N 6183) will only accept Extended ISO-Throttle Boss (P/N 6242).



MALTESE CROSS END CAPS

Replacements for ISO-Flame Grips or styling update for ISO-Grips. Includes standard length screws.

6245	Pair	\$24.99
-------------	-------------	----------------



ISO®-GRIP END CAPS

Replacements for ISO-Grips or styling update for ISO-Flame Grips. Includes standard length screws.

6243	Pair	\$24.99
6244	Each	\$12.99

ISO®-GRIPS for GoldWing

U.S. Patent # Des. 411,432

Combining style & comfort, Kuryakyn ISO-Grips are a quantum leap forward in hand grip design. Like the popular ISO-Pegs, these grips provide a soft, non-slip surface that dampens operating vibration. Recessed areas between the ISO-Pads permit air flow for added comfort in hot weather. The knurled accent ring adds a classy detail.

Fits: '75-'08 GoldWings

6180	ISO-Grips with Chrome Accent (pr)	\$69.99
-------------	--	----------------

Note: These grips do not support the heated grip option on many late Model bikes. They also are not compatible with "bar-end" weights found on many bikes. The majority of the time, removing these weights is a simple affair & the vibration absorbing quality of our ISO-Grips more than compensates for the vibration damping lost by removal of the bar-end weight.



Heated Grip Covers that are Easy to Install!



7436

6183

6242

New Sleeve Style Rubbers



ISO®-GRIPS

For Use With GL1800 Heated Grips

Patent Pending

Now you can have the luxurious feel & custom look of our ISO-Grips without losing the heat! This clamshell design attaches right over your stock grips allowing the heat to come through.

Fits: '06-'08 GL1800 Models with OEM heated grips.

6183	ISO-Grips for use with GL1800 Heated Grips (pr)	\$89.99
6184	Replacement Rubbers with New Sleeve Style for P/N 6183	\$19.99

Note: Will accept Extended ISO-Throttle Boss (P/N 6242) & all other Grip End Accessories (ex. P/N 6250 & 6253).

Shown with Red Accent Ring



HANDLEBAR ACCESSORIES



Mounts on Left or Right Side!

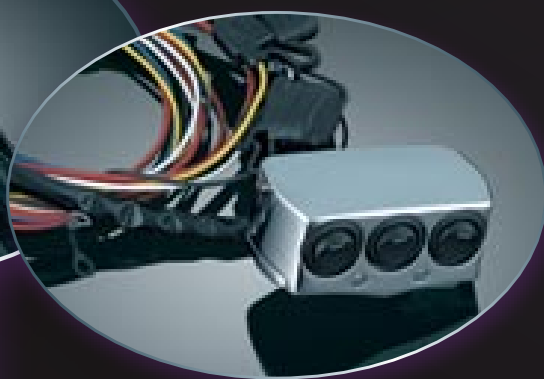

ACCESSORY SWITCHES for Master Cylinder Reservoir Covers

Keep control of your accent lighting & additional motorcycle accessories at the tip of your fingers with these master cylinder Accessory Switches. Rated for 12V & up to 10 Amp accessories each, these switches add convenience & style to controlling those extras you add to your motorcycle.

Fits: All GL1500 & 1800 Models

7803 | Accessory Switches for Master Cylinder Reservoir Covers (ea) | \$69.99

Note: Additional Metric Cruiser Fitments, page 70.



Adjust your hands up to 2" horizontally & 1-1/2" vertically



HANDLEBAR RISERS/ SETBACKS for GL1800

With 5 different position options, adjust your handlebars to make your GoldWing the most comfortable ride. With all the parts you need; we don't know anyone who offers this many options & convenience in one set.

Fits: '01-'08 GL1800 Models

7437 | Handlebar Risers for GL1800 (set) | \$69.99



ROADRUNNER DRINK HOLDER for GL from Leader



This is the ultimate drink holder for GoldWing riders. It's unique machined bracket fastens securely to the handlebar controls on either the GL1500 or GL1800. Includes 16-ounce stainless cup.

Fits: All GL1500 & 1800 Models

3689 | Roadrunner for GoldWing, Chrome (ea) | \$84.99

UNIVERSAL ACCESSORY & DRINK HOLDERS NEW

Attach your cell phone, mp3 player, or nearly any portable device directly to your clutch perch or master cylinder mount with our Universal Accessory Mount. It accepts belt clips, screw mounts, 4 hole AMPS pattern & hook-&-loop straps. Or if bringing along a beverage for those hot or cold days is what you're looking for, the new Universal Drink Holder Mount is for you. With the quick detach thumb screw you can remove the basket for a cleaner look as well. Both styles are equipped with a quick detach mounting plate that leaves a simple clamp when it is not in use.

Fits: All GL1500 & 1800 Models

1461	Universal Accessory Mount (ea)	\$59.99
1463	Universal Drink Holder with Stainless Mug	\$59.99
1469	Küryakyn Mug (ea)	\$16.99

Note: Additional Metric Cruiser Fitments, page 69.



Unfinished Prototype Shown- Production Bracket & Ring will be Chrome-Plated.

1463



1461

MASTER CYLINDER RESERVOIR COVERS

These chrome reservoir covers are an eye-catching replacement that really perks up the master cylinder area. Available plain or with our exclusive Küryakyn 1500 gold condor emblem for a distinctive styling touch.

Fits: GL1500 & GL1800 Models

7800	Chrome Reservoir Cover (pr)	\$24.99
7801	Chrome Reservoir Cover with 1500 Gold Condor Emblem (pr)	\$29.99



Note: 1800 Gold Condor Emblem sold separately (P/N 5152) See right.

L.E.D. BATTERY GAUGE

Our L.E.D. Battery Gauge is an array of L.E.D.'s indicating the operating voltage of the bike's electrical system. Green L.E.D.'s represent the normal operating range of your charging system, 12.5v to 14.5v. Amber L.E.D.'s warn the rider that the bike is not charging. If the reading drops below 10v or exceeds 15v, a flashing red L.E.D. will alert the rider of an impending stall or the possibility of damage to the battery &/or sensitive electronic components on the motorcycle. Simple two-wire connection & a compact size (about 2" x 3/4" x 3/16") make installation a breeze.

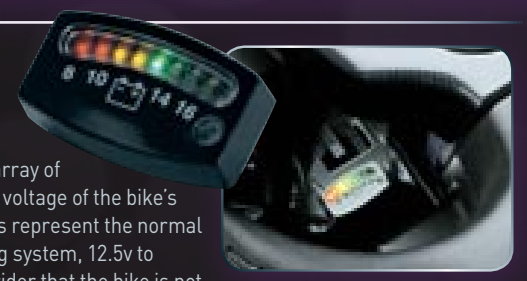

4219	L.E.D. Battery Gauge, Chrome (ea)	\$39.99
4218	L.E.D. Battery Gauge, Black (ea)	\$37.99

CONDORS for GL1800

These tasty little accents feature a gold electroplate finish & the 1800 emblem in the center. A strong adhesive backing is pre-applied to permit easy mounting in a variety of locations. Mini Condors are 1-3/4" wide & Medium Condors are 2-1/4" wide.

5152	Mini Condor for GL1800 (ea)	\$6.99
5153	Medium Condor for GL1800 (ea)	\$7.99



5153



5152

GOLDWING



AIRMASTER™

AIRMASTER™ DRAGON WINGS™ VENTED WIND DIRECTORS for GL1800 Patent Pending

Be in control of your riding environment. Dragon Wings put you in charge & allow you to manage & direct the wind with amazing effectiveness. Gain the full protection from your mirrors fully down the sides of your fairing. With two adjustable wind directors per side, you can direct wind down & away or up & into the fairing compartment in varying volumes. Drivers & passengers both benefit from less turbulence, rain, & debris. The dark tinted hard-coated polycarbonate adds a high-tech appearance with the best quality available.

Fits: All '01-'08 GL1800 Models

1388 | Dragon Wings for GL1800 (pr) | **\$169.99**

NEW
Excellent Wind Control for Both Hot & Cold Riding Days!

Kuryakyn COAT
HARD COATED POLYCARBONATE



NEW CARBON FIBER DASH COVERS for '06-'08 GL1800

Anything but ordinary! Give your dash the racy, high performance look of carbon fiber. This complete, 5-piece kit will really set your Wing apart from the crowd. Peel & stick installation is simple & requires no tools.

Fits: All '06-'08 GL1800 Models

3735 | Carbon Fiber Dash Covers (set) | **\$169.99**

Note: Not Suggested for use on air bag Models.

CUSTOM DASH for GL1800

Kuryakyn's custom dashes are an easily installed direct replacement for the stock GL1800 dash. Available with high-tech carbon fiber or classic walnut woodgrain patterns.

Fits: '01-'05 GL1800 Models

3711	Carbon Fiber Pattern Custom Dash (ea)	\$189.99
3712	Walnut Woodgrain Custom Dash (ea)	\$189.99



The Only Place You'll Get A More Calm, Quiet & Peaceful Riding Environment is in the Confines of Your Car!

Unfinished Prototype Shown



KURY COAT
HARD COATED POLYCARBONATE

AIRMASTER™ REAR AIRFOIL for GL1800 Patent Pending



If you want to greatly reduce buffeting & virtually eliminate annoying back draft, this Rear Airfoil is the answer. You will be amazed at the almost still environment created for both driver & passenger when used with your stock windshield or gain the ultimate in protection with the Performance Windshield. This dark smoked hard-coated polycarbonate Airfoil complements as a mere seven inch extension to the passenger seat.



Features:

- Hard-coated polycarbonate for quality, strength, & scratch resistance
- Quick detach
- Dark smoke tint with aerodynamic styling to complement passenger seat

Fits: All '01-'08 GL1800 Models

1380	Performance Windshield with Rear Airfoil (set)	\$399.99
1381	Performance Windshield (ea)	\$299.99
1384	Rear Airfoil (ea)	\$119.99

Note: Vent not included. The Performance Windshield has the standard cutout for installation of OEM windshield vent. For '01-'02 GL1800's without vent we suggest ordering OEM GL1800 Windshield vent for installation. Do not use Rain-X or other ammonia based cleaning or protection product on this product.

Riders Testimony

Our test riders could not believe the performance & left us with praise for creating a protected cockpit of air for both driver & passenger. The true amazements were there was "no buffeting or poor handling when passing through the traffic of 18 wheelers". There is nothing else out there that provides better wind protection unless you're getting in your car or truck.

AIRMASTER™ PERFORMANCE WINDSHIELD for GL1800 Patent Pending



Unfinished Prototype Shown

Being "in the wind" is a big reason why many of us ride. But, too much turbulent air detracts from the experience. The new Performance Windshield is only slightly larger than stock, but it's contoured design creates a more calm, comfortable envelope. Optical clarity is excellent, & the hint of a tint reduces glare without hindering visibility. Stock mounting points & adjustability is retained similar to stock. Unlike some larger replacement windshields, vehicle stability & handling are not affected & the drive is not crowded by the windshield.

Features:

- Hard-coated polycarbonate for quality, strength, & scratch resistance
- Black gradient with vinyl protectors on lower portion to avoid abrasion
- Approximately 3" wider per side with 2-1/2" additional height over stock & retains adjustability similar to stock





Three-Position Adjustability

Better Style & Function Than Other Brands



RIDER BACKREST

For GL1800 U.S. Patent # Des. 528,311

Ultimate comfort for the GL1800 rider! Hours in the saddle will feel like minutes in your favorite easy chair when you cruise with our Rider Backrest. Quick release mounts allow easy removal & adjustability to suit each rider. The entire backrest pivots forward at it's anchor points for smooth operation & easy access to the passenger seat. Stylized pivot covers add elegance to the design. The upholstered backrest pad matches the OEM seat in both texture & style & features a convenient rear mounted storage pouch accessible by your passenger for traveling necessities like cameras, sunscreen, sunglasses, tissue, or anything else you like to keep handy.

Fits: '01-'08 GL1800 Models

8990 | Rider Backrest for GL1800 (ea) | \$299.99

PASSENGER ARMRESTS

For GL1800 U.S. Patent # Des. 526,952

We realize it's hard to imagine being any more comfortable on the back of a GoldWing, but our Passenger Armrests prove that it's possible! The shapely chrome mounting brackets fasten to the trunk & provide a sturdy mount for the swing-away armrests. Our top quality padding matches the OEM texture & color for a 100% factory look. We also have incorporated a handy, swing-out cup holder for the ultimate convenience.

Fits: '01-'08 GL1800 Models

8991 | Passenger Armrests for GL1800 (pr) | \$249.99



GOLDWING



KÜRYAKYN CAN COOLER

Küryakyn can cooler conveniently fits into your Passenger Armrest drink holder.

Fits: Küryakyn Passenger Armrest (P/N 8991)

8985 | Küryakyn Can Cooler (pr) | \$4.99

PEGS FOR GOLDWING



DRIVER FLOORBOARD KIT for GL1800

U.S. Patent # Des. 531,092 & Des. 528,476

Put your feet in a more comfortable position, update foot controls, & improve the look of your bike all at one time. Our Driver Floorboard Kit includes a built-in heel-toe shifter & a brake lever for the ultimate in comfort & convenience. The latest addition to Kuryakyn's exclusive ISO® family, our finely chromed driver boards have cushy, full-length ISO rubber inserts to absorb vibration. The boards fold up for easy maneuvering in tight spaces & to allow access to the stock kickstand. The kit installs in minutes.

Fits: '01-'08 GL1800 Models

4038	Driver Floorboard Kit (pr)	\$399.99
4048	Replacement Shift Fork Bushings (ea)	\$9.99

4049	Replacement Board Guards (pr)	\$9.99
4449	Replacement Shift Arm Kit (kit)	\$79.99
4068	Replacement Rubbers (set/10)	\$39.99

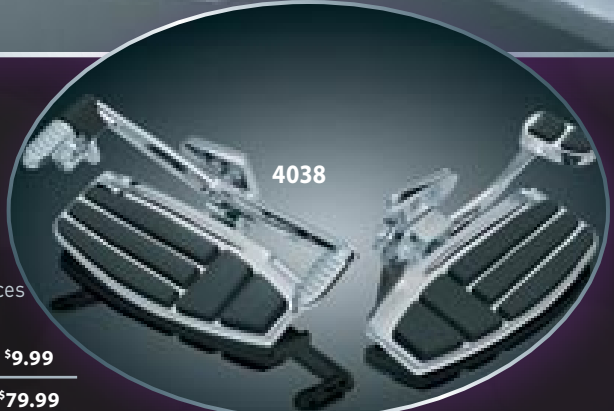

KICKSTAND EXTENSION

Infinitely adjustable, our Kickstand Extension can be installed on almost any motorcycle to provide improved access to the kickstand. When used with our Driver Floorboard Kit for GL1800 (P/N 4038), it allows the rider to deploy the kickstand without folding up the floorboard.



Fits: Stock OEM Kickstand or Stand-Rite Kickstand (P/N 7104)

7109	Kickstand Extension (ea)	\$39.99
-------------	---------------------------------	----------------

Note: For best results use our Stand-Rite Kickstand (P/N 7104) shown on page 25.

WIDE BRAKE PEDAL for GL1800 with Driver Floorboards



Give me a brake! Preferably a nice wide one that looks great, matches other accessories, & is easily installed!

Fits: Kuryakyn Driver Floorboards for GL1800 (P/N 4038)

4067	Wide Brake Pedal (ea)	\$29.99
-------------	------------------------------	----------------

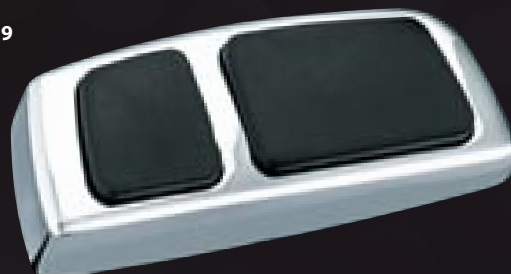

PEGS & ACCESSORIES

G O L D W I N G . G O

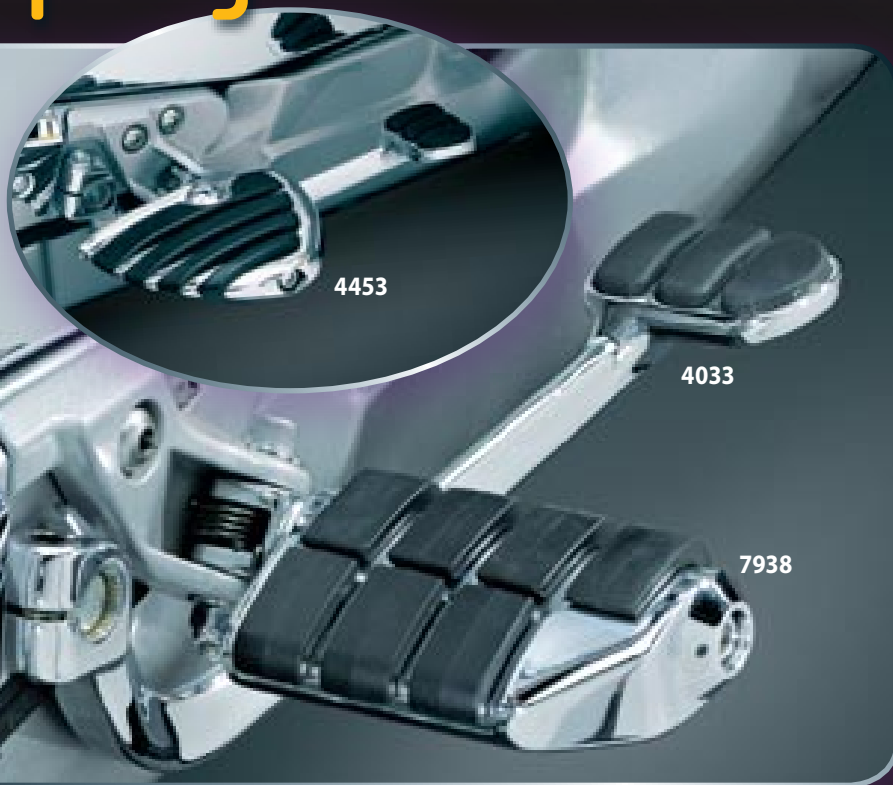

BRAKE PEDAL for GL1800

This replacement brake pedal is pure class. Smooth lines, deep chrome & black rubber ISO-Pads make this a beautiful addition to your Wing. If you are currently using other ISO components such as footpegs, grips & passenger boards, this is a perfect complement & rounds out the set nicely.

4033	Brake Pedal for GL1800 (ea)	\$79.99
4035	Replacement Pads (set /3)	\$6.99

PEGS Equipped With Adapters for GL1800

The first of the GL1800's had barely hit the street when riders began asking us for footpegs for them. Now available with required adapters, these classy, comfortable pegs can be installed in minutes.

7938	Dually Pegs for GL1800 (pr) <i>U.S. Patent # Des.405,393</i>	\$69.99
8023	Replacement Rubbers for Dually Peg	\$16.99
4453	ISO-Wings for GL1800 (pr)	\$99.99
4454	Replacement Rubbers for ISO-Wings	\$19.99

Note: Other peg styles are available. See complete selection on page 76.

ISO®-BRAKE PEDAL PAD for GL1500

The ISO-Brake Pedal Pad covers the raw, unfinished end of your brake pedal. Beautiful chrome with rubber inserts provide a non-slip surface.

Fits: All GL1500 and all Valkyrie Models (ex. Rune)

4025	ISO-Brake Pedal Pad (ea)	\$29.99
8081	Replacement Rubber Pads for 4025 (set)	\$9.99

DUALLY ISO®-PEGS for GL1500

U.S. Patent # Des.405,393

Direct replacement for the stock rider pegs on all GL1500 & Valkyrie (ex. Rune).

7945	Dually ISO-Peg for GL1500 & Valkyrie (pr)	\$69.99
8023	Replacement Rubbers for Dually Peg	\$16.99

Note: Other peg styles are available. See complete selection on page 76.



CHOOSE THE PEGS YOU WANT...

...and Select the Adapter you need.



SwingWing Peg
4467

SweptWing Peg
4464

Pilot Peg
4419



7939



8808

FOOTPEG ADAPTERS

Model	Year	Front	Rear
GL1800	'01-'08	7939	None
GL1500	'88-'00	7946	None

SPLINED ADAPTERS

Model	Year	Front	Rear
GL1800	'01-'08	8808	None

Splined Adapters required for SwingWing Pegs (P/N 4467). Floorboards (P/N 4455, 4457 & 7916) will not install on GL1800.

GOLDWING

Full Line of Peg Styles See Page 76



BRAKE PEDAL & ARM COVER for GL1800

For an easy & economical way to improve function & style on your bike, add our Brake Pedal & Arm Cover. The Brake Pedal Cover installs directly over your stock pedal, while the second cover goes directly over the stock arm to completely chrome this area. A simple yet cool upgrade to your stock parts.

Fits: '01-'08 GL1800 Models

4013	Brake Pedal & Arm Cover for GL1800 (set)	\$49.99
4029	Brake Pedal Cover	\$29.99



Shown with Dually ISO®-Pegs, (P/N 7938) sold separately, page 24.

HEEL-TOE SHIFTER for GL1800

We understand that while a lot of riders may want the convenience of a heel-toe shifter, not everyone wants to convert to floorboards. This simple kit installs in minutes & retains the stock footpegs. For added flair choose from any of our custom pegs found on page 76.

Fits: '01-'08 GL1800 Models

4039	Heel-Toe Shifter for GL1800 (ea)	\$179.99
4048	Replacement Shift Fork Bushings (ea)	\$9.99
4449	Replacement Shift Arm Kit (kit)	\$79.99



STAND-RITE KICKSTAND for GL1800

We are pleased to be able to offer you a beautifully chromed stand that works perfectly with our state-of-the-art floorboards & shifter & most other accessories you may desire.

Fits: '01-'08 GL1800 Models

7104	Stand-Rite Kickstand (ea)	\$89.99
-------------	----------------------------------	----------------

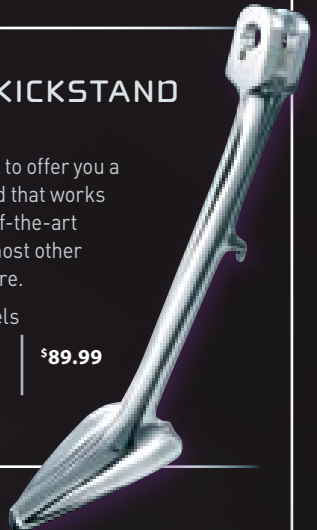

TECH-TIPS

Always check all fasteners on pegs & mounting hardware after installation. The assemblies do not always come pre-tightened. Periodic maintenance is recommended.



CHROME DRIVER PEG MOUNTS for GL1800

A great looking replacement for the stock painted footpeg mounts. Our chrome units look awesome with our pegs & Boomerang Frame Covers.

Fits: '01-'08 GL1800 Models

4544	Chrome Footpeg Mounts for GL1800 (pr)	\$79.99
-------------	--	----------------



Maximum Comfort
Cruise Pegs for
GL1500!

ERGO CRUISE PEGS

Ergonomically designed for maximum driver comfort, these mounts make possible an unbelievable range of adjustment for the tall, short or in-between rider.

The articulated mounting bracket is made of highly polished stainless steel for extreme strength, great looks & simple installation.

The 6" long chrome swingarm has an ingenious locking mechanism & is canted at a 6 degree angle which angles the pegs just the right amount for ideal comfort.

Fits: '98-'00 GL1500 & All Valkyrie (except Interstate)

4050	Ergo with Dually ISO-Pegs (pr) <small>U.S. Patent # Des. 405,393</small>	\$199.99
4040	Ergo with Lighted Cruise Boards (pr)	\$269.99
4041	Ergo with Unlighted Cruise Boards (pr)	\$259.99
4052	Ergo with ISO-Wings (pr)	\$209.99



4040



4041



4050

CRUISE FOOTREST MOUNTS WITH PEGS OR BOARDS for '88-'97 GL1500

The innovative cast mount provides a wide range of adjustment front to back to accommodate riders of just about any height. The mount also angles the pegs inward slightly for even more driver comfort.



4054

7330	Cruise Mounts with Dually ISO-Pegs (pr) <small>U.S. Patent #Des. 405,393</small>	\$149.99
4054	Cruise Mounts with Unlighted Floorboards (pr)	\$199.99



7330

ERGO TO ERGO II UPDATE

For riders wishing to update their original Ergo Pegs to the Ergo II type clamp. Retains existing arm & footrest.

Fits: '01-'08 GL1800 Models



4063	Ergo to Ergo II Update (pr)	\$119.99
-------------	------------------------------------	-----------------



TECH-TIPS

When installing any footpeg, always verify all fasteners are tight & secure - even those you don't adjust. We also recommend periodically checking all fasteners.

Cruise Pegs for GL1800



ERGO II CRUISE MOUNTS for GL1800

Ergo II Cruise Mounts are undeniably the best highway peg available for the GL1800. The sturdy two-piece clamp assembly is easily installed & locates the swingarm mounting point high & tight for excellent cornering clearance. Offered with numerous footrest options & providing a wide range of adjustability, the Ergo II is sure to please.



4064

Ultimate
Adjustability!

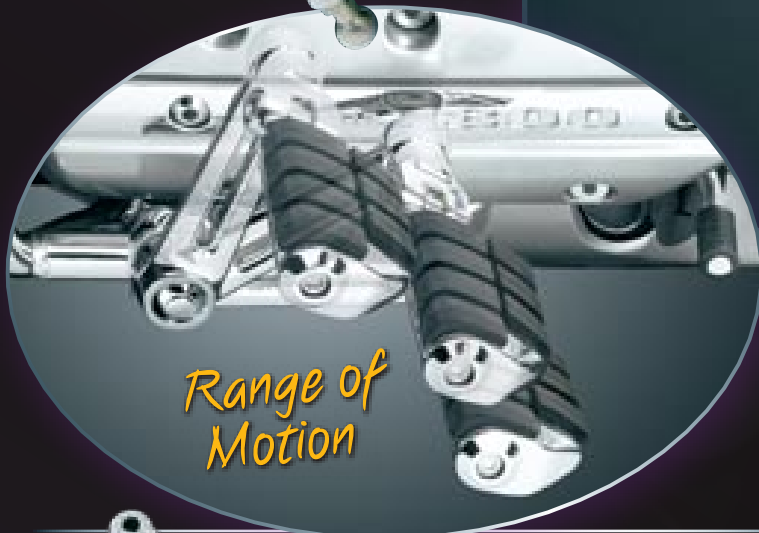

Range of
Motion



4056



REPLACEMENT ARMS for Ergo & Ergo II Cruise Pegs

Replacement arms are offered both to replace crash or tip-over damage & to help tailor the footpeg placement for taller or shorter riders. All Ergo Cruise Pegs come standard with 6" arms.

4060	Short Ergo Arm, 4-1/2" (pr)	\$49.99
4061	Long Ergo Arm, 6" (pr)	\$49.99



4058



4057

Fits: '01-'08 GL1800 Models

4056	Ergo II with Dually ISO-Pegs (pr) <small>U.S. Patent # Des.405,393</small>	\$199.99
4057	Ergo II with ISO-Wings (pr)	\$229.99
4064	Ergo II with Switchblade Pegs (pr) <small>U.S. Patent # 6,893,038 and Des. 506,707</small>	\$249.99
4058	Ergo II with Lighted Cruise Boards (pr)	\$279.99
4059	Ergo II with Unlighted Cruise Boards (pr)	\$259.99

Note: Kuryakyn Highway Pegs offer a wide range of adjustment. It is the responsibility of the installer or the end user to ensure they do not interfere with the operation or cornering clearance of the motorcycle.

MINI ARM for Ergo & Ergo II

Taller GL1800 riders, stretch your legs & be comfortable! Mini Arms position your feet at the ergo mount with full adjustability to be behind, at, or in front. Spaced out for easy leg clearance around the fairing. These are a must have for taller riders.

Fits: All Kuryakyn Ergo & Ergo II Cruise Pegs for GL1800/1500

4071	Mini Arm for Ergo & Ergo II (pr)	\$59.99
------	----------------------------------	---------



Fully Stretch
Out Your Legs!

Rendering Shown-
final design may vary.

LONG-HAUL COMFORT

GOLDWING . GOLD



OFFSET PEGS with Quick Clamps

U.S. Patent # Des. 405,393 & 411,440

This innovative cruise peg setup redefines the term "Long Haul Comfort". This system is adjustable enough to accommodate nearly any rider.

Fits: GL1500, Valkyrie, (ex. Interstate) & most bikes with 1" engine guards

7976 | Offset Dually ISO-Pegs with 1" Clamps (pr) | \$139.99



LONGHORN OFFSET PEGS with Quick Clamps

U.S. Patent # Des. 411,440 & 405,393

Incorporating our Longhorn Offset, this combination provides a wider range of adjustment than our standard Offset Pegs (P/N 7976). Works great on GoldWings or most bikes with 1" engine guards.

7980 | Longhorn Offset Dually ISO-Pegs with 1" Clamps (pr) | \$149.99

RIGHT ANGLE PEGS with Quick Clamps

U.S. Patent # Des. 405,393 & 411,440

A good option for cruise peg mounts on the 1800 - especially for the shorter rider. Because these mounts are attached to the clamp at a right angle, they can be positioned on engine guards in orientations impossible with other clamp-on pegs. This particular setup allows positioning on the 1800 engine guard at the closest point possible to the driver.

4509 | Right Angle Dually ISO-Pegs with 1" Clamps (pr) | \$149.99

Add any Male Mount Peg - Page 98!

LONGHORN OFFSET PEG MOUNT

U.S. Patent # Des. 411,440

The stylish peg mount provides 360° adjustability so it can be used to position the peg closer to the rider or further away. Its 3-1/4" arm gives an incredible 6-1/2" range of adjustment. Incorporating an innovative locking device, this mount is guaranteed not to slip.

7985 | Longhorn Offset with 1" Clamp (pr) | \$109.99

One-Inch Engine Guard on GL1800



TRANSFORMER FLOORBOARDS



REPLACEMENT RUBBER PADS for Transformer Floorboards

7010	Replacement Rubbers for One Transformer Board (set/11)	\$19.99
7009	Replacement Slim Rubbers for Swingarms (Both Boards) (set/4)	\$8.99
7008	Replacement End Rubbers for Swingarm (set/3)	\$8.99

KÜRYAKYN TRANSFORMER FLOORBOARDS

Küryakyn Transformer Floorboards blend style, function & comfort. A direct replacement for the stock passenger floorboards, the Transformer Boards bolt on in minutes. Even when not in use, these finely chromed boards are a great improvement over the dull aluminum stock units. When folded down, they offer a secure, comfortable perch for passengers. The stock height adjustability is still fully functional on GL1500 SE Models.

The most important & unique feature of this system is the hidden retractable passenger cruise pegs. A folding arm & footrest deploys to provide an alternate foot position 4-1/2" higher & 5-1/2" farther forward than the stock foot position.

7000	Transformer Floorboards Fits: '90-'00 GL1500 SE (pr)	\$219.99
7001	Transformer Floorboards Fits: GL1500 Aspencade (pr)	\$249.99
7005	Transformer Floorboards Fits: '01-'08 GL1800 (pr)	\$239.99

Note: P/N 7001 will also work on GL1500 Interstate Models that have been equipped with Hondaline Passenger Boards.

Enhance Passenger Comfort!

REAR ACCESSORIES

GOLDWING GOLDWING

LUGGAGE RACK
PG.36

ANTENNA FLAG
MOUNT PG.38

L.E.D. LIGHTED
TRUNK LID HANDLE PG.32

INFINITY LIGHTS
FOR TOUR BOX
(NOT SHOWN) PG.32

TRUNK TAILLIGHT
ACCENTS PG.33

LIGHTED TRUNK
MOLDING PG.31

SADDLEBAG TAILLIGHT
ACCENTS PG.33

LICENSE AREA
TRIM PG.32

LIGHTED SADDLEBAG
MOLDING PG.31

L.E.D. REAR REFLECTOR
CONVERSIONS PG.33

SADDLEBAG BOTTOM TRIM
MOLDING PG.31

REAR FENDER TRIM
PG.32

GLOW RING
EXHAUST
EXTENSIONS PG.34

DEBRIS MODULATOR
MUD FLAP PG.35

TRAILER HITCH
PG.35



3201

LIGHTED TRUNK MOLDING

For GL1800 U.S. Patent # Des. 491,493 & 488,105

Pure class best describes this beautiful Lighted Trunk Molding. Styled to be a perfect match for our Lighted Saddlebag Molding, they look incredible in a complete set. Two circuit L.E.D.'s function as both running & brake lights for a highly visible, long lasting light source that places a minimal draw on the electrical system. These great looking moldings install in a fraction of the time as old fashioned light bars.

Fits: '01-'08 GL1800 Models

3201	L.E.D. Trunk Molding Set, with Red Lens (3 piece set)	\$179.99
3221	L.E.D. Trunk Molding Set, with Chrome Lens (3 piece set)	\$179.99



3222

ON

OFF

3202

LIGHTED SADDLEBAG MOLDING

For GL1800 U.S. Patent # Des. 477,551 & 488,105

These chromed replacement lighted moldings add the sparkle & elegance of the old style chromed tubular light bars without the added weight, mounting holes, potential for rust, & maintenance. These replace existing parts on the bike so there is no added bulk. All stock mounting points & hardware are retained.

The state-of-the-art red L.E.D. lights have an eye-catching, brilliant quality that draws minimal power & generates very little heat. These lighted moldings look great by themselves, or with the other L.E.D. accessories that we offer for the GL1800. Any other type of light bar is now ancient history.

Fits: '01-'08 GL1800 Models

3202	L.E.D. Saddlebag Molding Set, with Red Lens (4 pcs)	\$239.99
3222	L.E.D. Saddlebag Molding Set, with Chrome Lens (4 pcs)	\$239.99



3213

Lit or Unlit Options

SADDLEBAG BOTTOM TRIM MOLDING

For GL1800 Patent Pending

Highlight this otherwise dull drab panel with our Bottom Trim Molding. Replace your stock components at the bottom of your saddlebags with lit or unlit moldings. The L.E.D. option adds that finishing touch to completely light up the rear molding of your bike. Perfect complement to our Lighted Trunk Molding & Lighted Saddlebag Molding.

Fits: '01-'08 GL1800 Models

3212	Saddlebag Bottom Trim Molding Non-lighted (set)	\$119.99
3213	L.E.D. Saddlebag Bottom Trim Molding with Red Lens Lighted (set)	\$159.99

PULSATING BRAKE LIGHT CONTROLLER

Activate up to 6 brake lights to flash automatically & then stay on with a single squeeze of your brakes. Controller does not harm the life of your lights so ride in confidence & be seen.

Fits: All GL1500 & GL1800 Models

908	Pulsating Brake Light Controller (ea)	\$69.99
-----	---------------------------------------	---------





Unfinished Prototype Shown

Rendering Shown - final design may vary.

INFINITY LIGHTS for GL1800 Tour Box

U.S. Patent # 7,029,152

Few GoldWing accessories will leave as many people staring in disbelief as Infinity Lights. Performing double duty, they appear as graceful chrome accents until you bring them to life with the supplied controller. Now, an array of multi-function L.E.D.'s illuminate steadily, flash, or continuously fade through red, lime, ice, sky blue, dark blue, purple & green in a display that gives the illusion of infinite depth. Color, flash speed, & color cycle rate are totally variable & power draw is minimal.

Fits: All '01-'08 GL1800 Models

4622 | Infinity Lights for Tour Box (pr) | \$299.99

Note: Works great with or without Passenger Armrests.

7-Colors in One!



L.E.D. LIGHTED TRUNK LID HANDLE for GL1800

Style & function become one when you add a handle to the tour trunk while positioning an L.E.D. brake light up higher for added visibility. This handle also works with the Honda spoiler.

Fits: All '01-'08 GL1800 Models

3215 | L.E.D. Lighted Trunk Lid Handle for GL1800 (ea) | \$99.99



LICENSE AREA TRIM WITH LIGHTS for GL1800

U.S. Patent # Des. 528,486

It just seemed to us that the factory forgot something between your saddlebags - it looks so empty. Our trim changes all that. It gives the back of your Wing a whole new personality along with added visibility. Brilliant L.E.D.'s light up while running & go "super bright" when you hit the brake. No cut & splice necessary, just a simple plug-in for wiring.

Fits: '01-'08 GL1800 Models

3135 | License Area Trim with Red Light (Red Lens) (ea) | \$119.99

3136 | License Area Trim with Red Light (Clear Lens) (ea) | \$119.99

REAR FENDER TRIM for GL1800

This handsome trim strip is a natural complement to the Debris Modulator Mud Flap & our trick Lighted Molding. It installs easily on the bottom edge of the rear fender & provides a classy finishing touch.

Fits: '01-'08 GL1800 Models

9017 | Rear Fender Trim (ea) | \$29.99



3135

9017



TRUNK TAILLIGHT ACCENTS for GL1800

Simply peel & stick these stylish chrome accents to the bottom edge of your tour trunk brake lights for that perfect sparkle. Looks great alone, but complete the style with Kuryakyn Saddlebag Taillight Accents (P/N 3209). These accessories also coordinate well with Kuryakyn Trunk & Saddlebag Molding.

Fits: All '01-'08 GL1800 Models

3208 | Trunk Taillight Accents for GL1800 (pr) | \$39.99

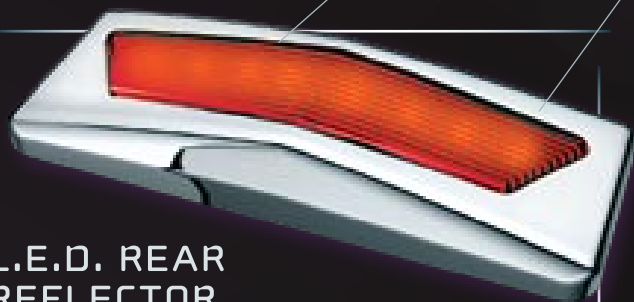

L.E.D. REAR REFLECTOR CONVERSION for GL1800

Here's yet another way to easily light up the night. This simple conversion kit replaces the stock red reflector found on the rear center panel of the GL1800. With plug-in wiring, the kit will have you styling in minutes. Rear reflector functions as running light & brake light for increased visibility.

Fits: '01-'08 GL1800 Models

7456 | L.E.D. Rear Reflector Conversion (ea) | \$59.99



SADDLEBAG TAILLIGHT ACCENTS for GL1800

These simple peel & stick chrome accents divide the clear & red section of your GL1800 saddlebag taillight. Looks great alone but complete the style with Kuryakyn Trunk Taillight Accents (P/N 3208). These little beauties also coordinate well with Kuryakyn Trunk & Saddlebag Molding.

Fits: '06-'08 GL1800 ONLY

3209 | Saddlebag Taillight Accent for GL1800 (set) | \$49.99



EXHAUST ADDITIONS

GOLDWING . G



TURNDOWN EXHAUST EXTENSIONS for GL1800

Our sleek Turndown Exhaust Extensions give your GL1800's exhaust a smooth, finished appearance. Beautiful chrome & sturdy steel construction will provide years of trouble-free service. They quickly & easily replace the stock exhaust tips, no modification required!

Fits: '01-'08 GL1800 Models

7606	Turndown Exhaust Extensions for GL1800 (pr)	\$129.99
-------------	--	-----------------



TRIPLE STRAIGHT EXHAUST EXTENSIONS for GL1800

These burly Exhaust Extensions really make a statement. Their size & six outlets elude to the power of the 1800 c.c. giant. Although the six outlets are massive for the appearance of a high performance exhaust system, they are actually sealed off & the exhaust gases are directed downward, out the bottom of the extension. This will keep the visible end of the extension clean & it will aid in keeping soot off saddlebags & trailers. These extensions easily replace the stock muffler tips & include necessary mounting hardware.

Fits: '01-'08 GL1800 Models

7604	Triple Straight Exhaust Extensions for GL1800 (pr)	\$169.99
-------------	---	-----------------



GLOW RING EXHAUST EXTENSIONS for GL1800

We can't think of anything that would add more pizzazz to the rear of your Wing. Everyone following you will notice these babies. Glow Rings are offered two ways; as a complete set of exhaust extensions or as end-caps only for those wishing to update existing Triple Straight Exhaust Extensions (P/N 7604).

Fits: '01-'08 GL1800 Models

7602	Glow Ring Exhaust Extensions for GL1800 (pr)	\$269.99
7601	Glow Ring End Caps for P/N 7604 (pr)	\$189.99

TRAILER WIRING HARNESSES



The Trailer Isolation Relay Package is required for all applications. This harness safely & properly applies the load from the trailer lighting to the battery & not to the rest of the bike's wiring/relays/fuses. Subharness assemblies are required to complete the installation & are sold separately. Specific subharnesses are available for all GL1500 & all GL1800 with a universal subharness offered for other motorcycles. The 4-wire Trailer Converter is required to connect the 5-wire Trailer Isolation Relay Package to trailers with only 4 wires.

7660	Trailer Isolation Relay Package (ea)	\$64.99
7661	Subharness for '88-'00 GL1500 (ea)	\$9.99
7662	Subharness for '01-'08 GL1800 (ea)	\$9.99
7663	Universal Subharness (ea)	\$9.99
7664	4-wire Trailer Converter (ea)	\$29.99

DEBRIS MODULATOR MUD FLAP for GL1800



Helps reduce road spray & leaves the dirt behind you. Black & chrome with 2 stylized lenses. The run-&-brake function of these lights adds an extra measure of visibility to boot!

Fits: '01-'08 GL1800 Models

7251	Debris Modulator Mud Flap (ea)	\$149.99
7248	Mounting Kit for use without Kuryakyn Trailer Hitch (ea)	\$39.99
7249	Mounting Kit for use with Kuryakyn Trailer Hitch (ea)	\$21.99
7646	Mudflap Adapter Required when using Debris Modulator with Mounting Kit (P/N 7248) & Exhaust Extension (P/N 7604 or 7602) (ea)	\$24.99



TRAILER HITCH BALL COVER

Fits: All 1-7/8" & 2" balls (Includes foam lining)

7658	Trailer Hitch Ball Cover (ea)	\$9.99
-------------	--------------------------------------	---------------

TRAILER HITCH RECEPTACLE



5-pin receptacle with a chrome mounting bracket.

9183	Trailer Hitch Receptacle, Universal (ea)	\$44.99
-------------	---	----------------

Note: Will not install with Trailer Hitch Rack (P/N 7643).



*Awesome Key Features:
Mounts simply clamp around the OEM rear saddlebag guard, providing an easily accessible, sturdy anchor point for the hitch. Loosening the pipes &/ or saddlebags is not necessary for hitch installation.*

TRAILER HITCH for GL1800

Our Trailer Hitch for the GL1800 is good looking, strong, & very easy to install. This hitch features a 6 point mounting system for superior strength & rigidity. Installation can be performed easily with the bike on it's center stand, & requires only a few common hand tools. When installed, the mounting framework is completely out of sight. Only the hitch & ball assembly & front mounting points are visible. The rear support plate is easily removed for quick & effortless tire changes. We feel there is no stronger, easier to install hitch available from any source, at any price.

Fits: '01-'08 GL1800 Models

7647	Trailer Hitch for GL1800 (ea)	\$299.99
-------------	--------------------------------------	-----------------

TRAILER HITCH RACK for GL1800

Bring a fully loaded cooler or those extra items with you that just don't seem to fit in your trunk. Simply install the mounting plate beneath your trailer hitch ball & this rack quickly attaches or detaches in seconds.

Dim: 18" wide x 12" long x 1-1/2" deep, weight = 6-1/2lbs

Fits: Kuryakyn Trailer Hitch (P/N 7647) & Universal Applications*

7643	Trailer Hitch Rack (ea)	\$159.99
-------------	--------------------------------	-----------------

Note: Requires Trailer Hitch (P/N 7647) for installation, sold separately. This product is not intended to be used while pulling a trailer. Suggested weight limit is 35lbs for appropriate handling & cornering.

*Universal mounting under hitch ball, Requires a flat/unrestricted area 5" wide x 2-1/2" long & ball stud able to accept a 1/4" spacer. Will not install with Trailer Hitch Receptacle (P/N 9183).

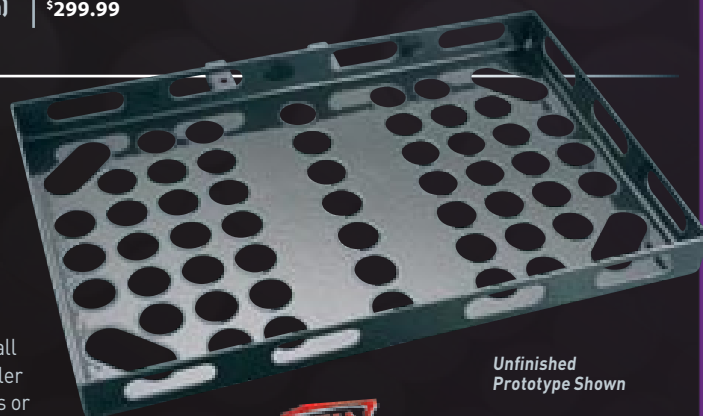

Unfinished Prototype Shown



LUGGAGE HELPERS

. GOLDWING . GOLDWING



Raise Your Luggage Rack 5/8" for Easier Cleaning

7151

7154

LUGGAGE RACK RISERS

For GL1800

By popular demand, we now offer a kit to raise our Luggage Rack (P/N 7151) by 5/8" — & gives you a larger diameter footprint. This will make cleaning under your rack easier as well as spread the load a bit. Reuses stock mounting holes if you already have a luggage rack.

Fits: '01-'08 GL1800 Models (For use with Kuryakyn Luggage Rack P/N 7151)

7154 | Luggage Rack Risers for GL1800 (set) | \$39.99



LUGGAGE RACK for GL1800

The styling of our Luggage Rack for the GoldWing is as fresh as the look of the GL1800! The billet aluminum construction has a burly look & is extremely strong. Finished in dazzling chrome of course!

Fits: '01-'08 GL1800 Models

7151 | Luggage Rack (ea) | \$239.99

Note: Luggage Rack Risers sold separately.



DELUXE CONVERTIBLE™ LUGGAGE RACK BAG with Protective Cover

Bring everything you need with you! Elastic mesh pockets & multiple pouches make your items readily accessible. 1200 Denier nylon construction, heavy-duty zippers, & zip-out rain cover. Bags also feature mounting straps utilizing both hook-&- loop fasteners & elastic shock cords. Attaches to GL1500 & GL1800 racks as well as most other racks on the market.

4162	Black (ea)	\$49.99
4165	Black/Silver (ea)	\$49.99

LID ORGANIZER BAG

For GL1800



Is your trunk compartment beginning to resemble the "junk drawer" in the kitchen? At least keep important or fragile items at your fingertips with the Lid Organizer Bag. A variety of padded & see-through mesh compartments offer protection & easy accessibility for frequently used items. Who says you can't take it with you? Quick disconnect fasteners & handles make it easily portable.

Included Items: Lid Organizer Bag, 1/4 Turn Mounting Connectors

Dim: 12" Tall x 22" Wide

Fits: All '01-'08 GL1800 Models

4135 | Lid Organizer Bag for GL1800 (ea) | **\$49.99**



Convenient 5" x 7" Flip-Out Mirror

GRANTOUR BAG

This versatile bag is the ultimate companion for weekend trips or long tours. A semi-rigid internal framework serves two purposes; It helps the main compartment hold its shape – even when empty – & it provides adjustable lumbar support for the rider's back. Large zipper pulls are glove-friendly & the retractable locking device keeps the bag right where you want it. Made of 1200 Denier & leather, the weather-resistant GranTour Bag comes with a rain cover for added protection.

Included Items: Bag, Passenger Seat Mounting Pad System, Adjustable Straps, Retractable Lock & Rain Cover

Dim: 18" Tall x 14" Deep x 20" Wide

4141 | GranTour Bag | **\$189.99**

Note: Additional Metric Cruiser applications, page 121.

Additional Luggage Options See Pages 121-130



New Application!



Use As A Driver Backrest!

DAILY TOUR BAG



The perfect day bag! The Daily Tour Bag provides just enough room for items needed on a full day or overnight journey. The semi-rigid bag holds its shape empty or full & mounts with ease on the back of your Luggage Rack.

Mounting Options:

- Tour-Pak luggage rack (Works great on large or small Tour-Pak racks)
- Backrest with or without a luggage rack (with 10" of clearance from the top of the backrest down)
- Solo luggage rack

Features:

- Large front hatch & end hatch allow ample access for loading & unloading
- Side pockets for additional storage
- Waterproof zippers with rain cover
- 1200 Denier & semi-rigid construction for durability & shape retention

Included Items: Bag, Shoulder Strap, Adjustable Universal Straps, "Y" Strap & Rain Cover

Dim: 12" Long x 10" High x 15" Wide

4133 | Daily Tour Bag | **\$119.99**

Note: Additional Metric Cruiser applications, page 129.



PATRIOTIC PARADE

GOLDWING . GOLDWING . GOLDWING



ANTENNA FLAG MOUNT WITH FLAG for GL1800

This is definitely an easy, out of the way antenna base flag mount. Made of sturdy aluminum, this flag is 4 1/2" x 8 1/2" with a total height of about 12". Just tighten a set screw & hit the road with pride.

4233	Antenna Flag Mount with Flag for GL1800 (ea) Fits: '01-'08 GL1800 Models with stock antenna or over approximately a 0.6" tube	\$59.99
4253	Antenna Flag Mount with Flag for GL1500 (ea) Fits: All GL1500	\$59.99



ANTENNA MOUNT FLAG

Secure this American flag to your bike's antenna quickly & easily. Includes both an American Flag & a plain, customizable white flag to help you stand out at the next rally. [Flags measure 6"x8"].



4217	Antenna Mount Flag (ea)	\$16.99
-------------	--------------------------------	----------------



FLAG POLE & HOLDER FOR LUGGAGE RACKS

Fly your flag proudly. Highly stylized holder allows you to adjust the angle of the staff without tools. Use the flagpole included in the kit for a blended, one-piece look, or insert your own pole – the tapered holder will secure a 1/4" to 3/8" flagpole. Two versions are offered; one specifically designed for our Luggage Rack for GL1800 (P/N 7151) & one designed for our Tubular Luggage Rack for GL1500 (P/N 7150) or any other racks or rails constructed of 1/2" tubing. Includes a 4-1/2" x 8-1/2" American flag.

4216	Flag Pole & Holder (ea) Fits: Kuryakyn Luggage Rack for GL1800 (P/N 7151)	\$79.99
4215	Flag Pole & Holder (ea) Fits: Kuryakyn Luggage Rack for GL1500 (P/N 7150) or other 1/2" tubing applications	\$79.99



PRIMOSHIELD™ FULL COVER for Touring Bikes

Designed on the GL1800, our cover is cut generously enough to accommodate most Touring Bikes (H-D FLHT, GL1800, GL1500, etc.). A soft fabric liner protects your windshield & fairing from abrasion. The bottom panels are heat/scorch resistant & includes an elastic hem coupled with reinforced grommets & shock cords to ensure great fit.

4120	Black PrimoShield Full Cover	\$69.99
4122	Silver PrimoShield Full Cover (ea)	\$69.99

PRIMOSHIELD™ HALF COVER

Our Half Cover is lightweight, compact, water-resistant & packed with features. A soft lining provides windshield protection, an elastic hem helps the cover fit snugly, & reinforced grommets with shock cords provide additional security. A handy storage pouch makes it easy to stow away.



4121	Black PrimoShield Half Cover (ea)	\$49.99
4123	Silver PrimoShield Half Cover (ea)	\$49.99



**Find GL1500 Grips & Grip Accessories on Pages 16 & 17
& GL1500 Pegs on Pages 24-29!**

INNER MIRROR TRIM for GL1500

Our mirror trims are easy to install & give you that final touch or accent.

Fits: All GL1500 Models

7516 | Inner Mirror Trim (pr) | \$19.99



REPLACEMENT PUSH-IN BULBS

These bulbs are direct replacements for all Kuryakyn Diamond Lights.

3101	Replacement Bulb - #161 Low Intensity (10-pk)	\$9.99
3102	Replacement Bulb - #168 High Intensity (10-pk)	\$9.99
3103	Replacement Bulb - #161 Low Intensity (ea)	\$0.99



DIAMOND LIGHTS

Our exclusive Diamond Lights have dual light sockets for running or running/stop light applications.

3098	with Red Lens (pr)	\$39.99
3100G	with Red Lens (ea)	\$24.99
3100H	with Red Lens (ea)	\$24.99



L.E.D. WEDGE BULBS

An L.E.D. replacement for 12 volt #161 or #168 style push-in bulbs. Great way to reduce the load on your charging system.

4802	Red L.E.D. Wedge Bulb (ea)	\$9.99
4805	Amber L.E.D. Wedge Bulb (ea)	\$9.99



TUBULAR GRILL for GL1500

Add some real class with this quality, chrome tubular steel radiator grill. An easy addition that gives a whole new look to all GL1500.

7550 | Tubular Radiator Grill (ea) | \$69.99

POSITION LIGHT PROTECTORS for GL1500

This thick, transparent pre-cut vinyl film sticks directly to the position light lenses to protect them.

Fits: All GL1500 Models

3007 | Position Light Protector Only (pr) | \$19.99

DIAMOND LIGHT LENS GRILLS

These grills give all Kuryakyn products with Diamond Lights that final touch.

3600 | Diamond Light Lens Grills, Chrome (pr) | \$10.99



FAIRING SIDE MOLDING TRIM for GL1500

This one piece Fairing Side Molding Trim really adds sparkle to the GL1500 fairing. Gently radiused edges & angles create a flowing appearance that complements the lines of the fairing. For the ultimate effect, use these in combination with our Fairing Exit Grills.

Fits: All GL1500 Models

7311 | Fairing Side Molding Trim (pr) | \$59.99

CHROME FAIRING EXIT GRILL COVERS for '98-'00 GL1500

Tired of looking at the "black hole" in the side of your GL1500 fairing? Transform that dark void into a gleaming, aggressively styled chrome accent. With our Fairing Side Molding Trim you'll be the talk of the town!

Fits: '98-'00 GL1500 Models

3618 | Chrome Fairing Exit Grill Covers (pr) | \$69.99

Note: No need to disassemble fairing for installation.

L.E.D. RING OF FIRE™ for GL1500

Enhance your wheel with super-bright rows of L.E.D.'s. Amber L.E.D.'s shine outward & your choice of color shine inward. Lazer Spoke Accents (P/N 3699) are the perfect complement!



7400	L.E.D. Ring of Fire, Amber Light Shining Inward (pr)	\$119.99
7401	L.E.D. Ring of Fire, Blue Light Shining Inward (pr)	\$169.99
7402	L.E.D. Ring of Fire, Blue & Green Light Shining Inward (pr)	\$169.99
7403	L.E.D. Ring of Fire, Red & Blue Light Shining Inward (pr)	\$169.99
7404	L.E.D. Ring of Fire, Green Light Shining Inward (pr)	\$169.99



LAZER™ SPOKE ACCENTS for GL1500

Intensify flashes of sunlight or reflect rays of color from your Ring of Fire with these great accents.

3699 | Lazer Spoke Accents (set) | \$89.99



